



Satellite

Design by Edward Barber & Jay Osgerby

Internationally acclaimed designers Edward Barber and Jay Osgerby founded their studio in 1996 in London.

They received numerous awards and their work is held in permanent collections around the world including the V&A Museum, London; New York's Metropolitan Museum of Art; London's Design Museum; and the Art Institute of Chicago.



Satellite

Design by Edward Barber & Jay Osgerby

Quote by the designers:

"An exercise in graphic composition and organised volumes. It is about proportion, modularity and purity with character. We see an array of objects, some coloured, resting on trestle bases - a series of ideograms."

This informal character implies variation, movement and adaptability. The temporary made temporarily permanent. Time and space, balance and expression".

Edward Barber, Jay Osgerby



quodes®

Materials

Corpus, shelves, front panels: MDF.
Corpus and shelves also available in veneered MDF.

Drawers:
MDF with satin Traffic White laminate.

Cable management:
hole in shelf and in bottom of left and right section of each cabinet.

K-shaped base:
powder coated aluminium/ steel in Satin Traffic White (RAL 9016), other colour on request.

Cabinets on plinth:
plinth made of MDF incl. adjustable feet.
Edges lacquered in corpus colour.

Cabinet on round leg:
solid oak or lacquered in corpus colour.

Mounting

Satellite comes fully mounted; only the base / plinth / feet have to be mounted.
Flat pack delivery is also possible.

Modular dimensions

Length 67,5 / 135 / 202,5 / 270 cm.
Corpus height 25 / 58,5 / 75 / 117 cm. Depth 47 cm.
Exception to modular dimensions: bedside tables.

If placed on the floor:

- Height K-shaped base: 20 cm high
- Height plinth: 4 cm high
- Height round leg: 8 cm high

Sustainability

We use water based lacquer where possible.

All cabinets can be disassembled, lacquered in new colours and re-used.

Colour options

Quodes offers its clients for most products endless colour options, which means that nearly all regular RAL and NCS colours are possible.

We also developed a Quodes Colour Plan, which is a selection of matching colours that we really like a lot. Our clients can select colours from this plan or pick their own.

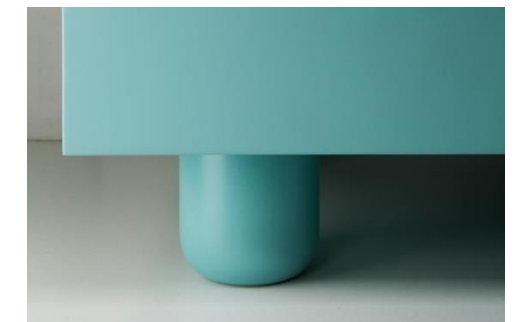

Colour options continued

Also available as download: the colour selection by the designers of the Satellite range, Edward Barber & Jay Osgerby.

Option 1 = corpus exterior satin Traffic White RAL 9016 water based lacquer + front panels satin Traffic White RAL 9016 polyester lacquer

Option 2 = same as 1, but front panels in another regular *satin* RAL or NCS colour or colour combination

Option 3 = same as 1, but front panels in any regular *high gloss* RAL or NCS colour or colour combination

Option 4 = corpus exterior in another regular satin RAL or NCS colour + front panels in a satin colour, all with polyester lacquer finish

Option 5 = same as 4, but front panels in any regular *high gloss* RAL or NCS colour or colour combination

- Cabinet interior / back / below bottom, shelves and drawer containers are satin white, but can be lacquered in colour upon request, extra charge.
- Non- regular colours like special effect colours upon request.

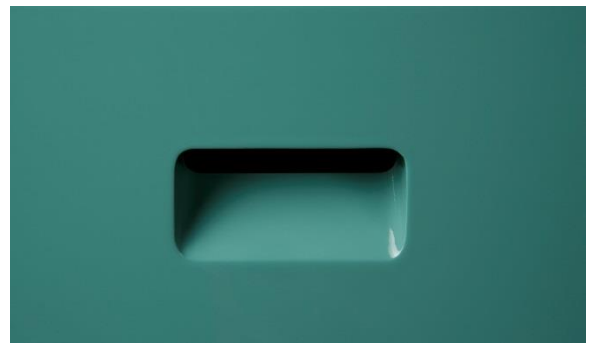

Satellite bedside cabinets

corpus height 25 & 41,5 cm

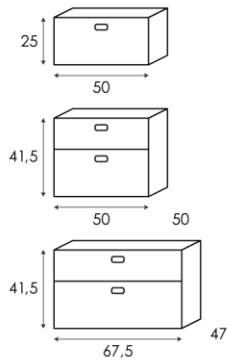

possible functions/module

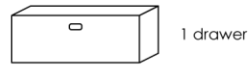

on floor or wall mounted

on leg:  height 8 cm

on base:  height 20 cm

on plinth:  height 4 cm

or wall mounted

Satellite side board cabinets

corpus height 58,5 cm

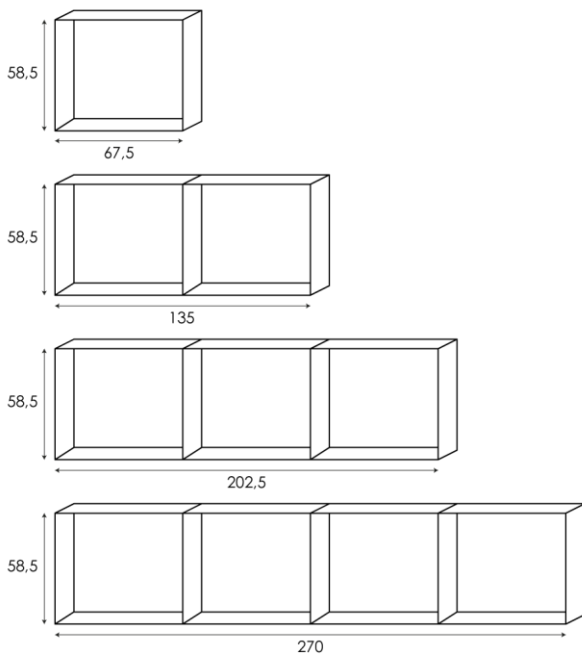

possible functions/module

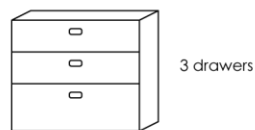
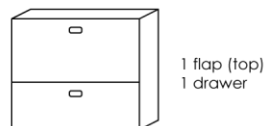
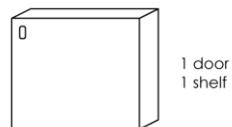

on floor or wall mounted

on leg:  height 8 cm

on base:  height 20 cm

on plinth:  height 4 cm

or wall mounted

Satellite low board cabinets

corpus height 25 cm

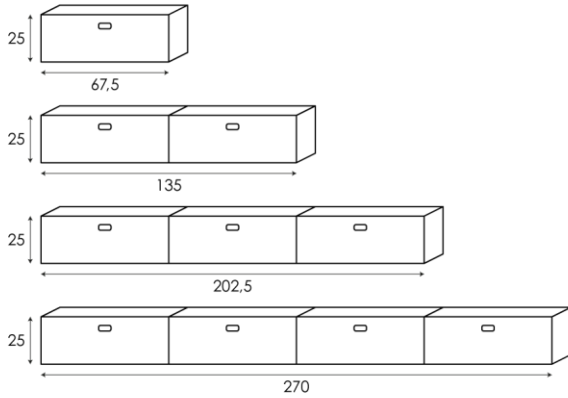

possible functions/module

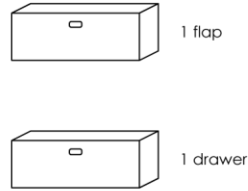

on floor or wall mounted

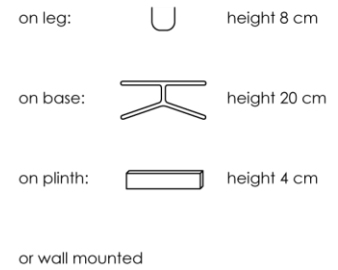

Satellite high board cabinets

corpus height 117 cm

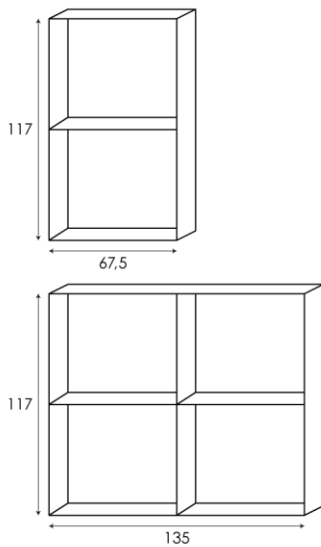

possible functions/module

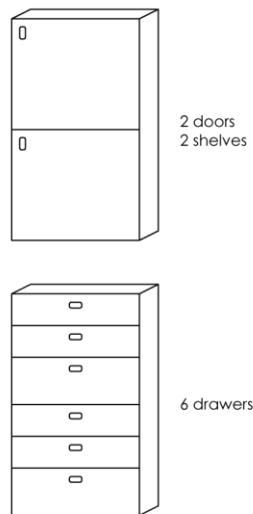

on floor

